

OCTAVE LEVENSPIEL

Chemical Engineering
Department, Oregon State
University, Corvallis OR 97331

SCIENTIFIC PAPER

591.044:598.19"63"

ATMOSPHERIC PRESSURE AT THE TIME OF DINOSAURS

If we visit dinosaurland we will come across some of the most amazing and puzzling phenomena. For example: how can a flying creature as large as a giant quetzalcoatlus (12–15 m wingspan) actually fly when aerodynamic theory and biology both say that it cannot. Also, how can a giant dinosaur such as an apatosaur pump blood up to its brain (more than 13 m above its heart) when animal energetics and physics say that in no way can it do it. Do we have to change the laws of physics and biology? I don't think so. Instead we have to accept that ancient Earth's atmospheric pressure was very different from what it is today. This talk will explore this new picture of our earth's past. Come explore it with me.

Key words: Atmospheric pressure, Aerodynamic theory, Animal energetics, Quetzalcoatlus, Dinosaur.

Scientists have exhaustively studied Earth's surface extracting its history from rocks and ocean bottoms. However, little attention has been given to the history of Earth's atmosphere because its historical record is ephemeral. In fact, most scientists have just accepted that the atmosphere was not much different in the past from what it is today. True, some [1,2] have speculated that the CO₂ concentration was as much as 800 times larger than today's value, or about 0.25 bar, but little else is assumed to differ.

THE BIOENERGETIC PROBLEM OF THE QUETZALCOATLUS

In the Cretaceous fossil record we find flying creatures which have an estimated mass between 86 and 100 kg [3]. The Washington DC Museum of Natural History displays a full sized model of the Quetzalcoatlus having a 13–15 m wingspan, while a Texas find is estimated to have a wingspan of 15.5 m [4]. This is about half the wingspan of a Boeing 737 commercial airliner, see Figure 1. How could such a large creature fly?

Today, the world's largest flying birds, the South American condor, the Australian kori bustard, and the largest European swan have wingspans no more than 4 m. Considering the limitation of skeletal and muscle structure, physiologists and aerodynamicists [5,6] estimate that these birds which weigh up to 14.5 kg, represent the upper size limit of creatures that can support and propel themselves through air. How then could 86–100 kg creatures fly in the age of dinosaurs, 64–100 Mya? Let's see what explanations have been forwarded to date to resolve this anomaly.

1. The biology of these ancient flyers differs from today's flyers in that they were more efficient in their use

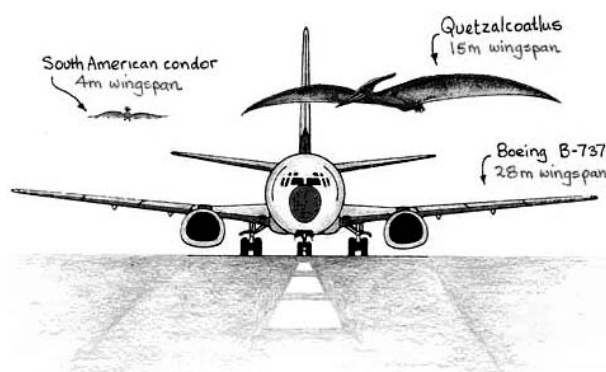

Figure 1. Wingspan of a quetzalcoatlus compared to today's largest bird and a Boeing 737 jet aircraft.

of oxygen, living at a much higher metabolic rate. From biological considerations this is quite unlikely.

2. These creatures were not true flyers. They stay on the ground and waited for a strong wind. With a wind speed of over 5 m/s they would spread their wings and glide about.

3. They sat on top of hills peering down. When they spied dinner hopping about down below they would swoop down, snatch their meal and then trudge back up the hill, to rejoin their cousins there, see Figure 2.

However, an analysis by Bramford and Whitfield [9] raised all sorts of difficulties with these explanations. They suggest:

1. The pteranodon could not stand bipedally because its legs were positioned wrongly on its body, see Smith [5].

2. It probably slid along on its stomach by reaching forward with its legs gripping the ground with its feet and pulling itself along, as does a crawling bat. Hankin and Watson [10] and Abel [11] come to similar conclusions.

3. Most importantly, large pteranodons appear to have lacked the physical power to perform hovering,

Plenary lecture at SEECChE 1, Beograd, September 25–28, 2005

Author address: O. Levenspiel, Chemical Engineering Department, Oregon State University, Corvallis OR 97331
E-mail: levenspo@peak.org
Paper received and accepted: February 12, 2006

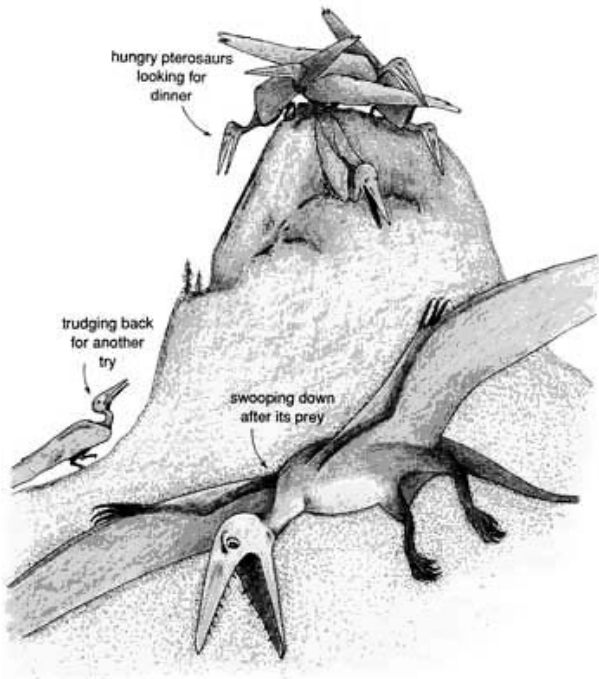

Figure 2. One theory holds that pterosaurs may only have glided rather than flown

thus could not have taken off from level ground. So it probably lived at edges of cliffs, see Romer [12].

4. To counter this deficiency others proposed that the Andes in the southern half of South America somehow did not exist 60 Mya, so the strong westerly winds (the "roaring 40's") could sweep practically

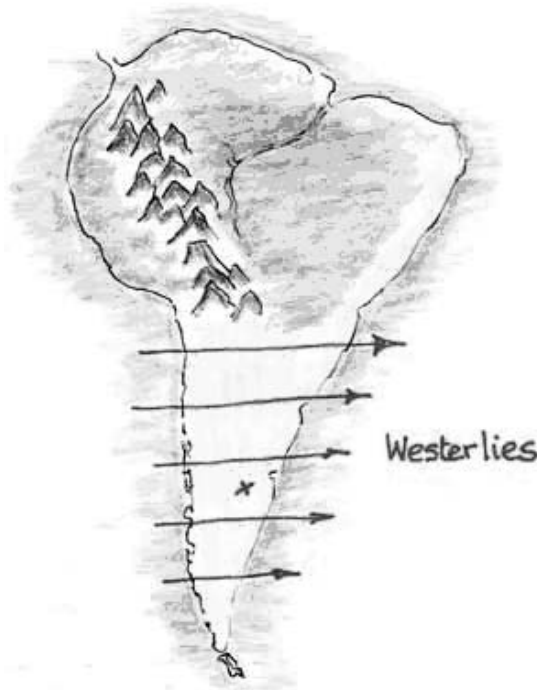

Figure 3. Southern South America minus the Andes mountain range will allow strong prevailing westerly winds to blow continually

continuously across the low-lying continent unopposed by any mountain range. This allowed pterosaurs to fly, see Figure 3.

All these difficulties lead to improbable scenarios. To have survived and thrived for millions of years, these flyers had to be fast, efficient, and well adapted to their environment.

Let's see what physics and physiology can tell us.

The power of resting warm-blooded creatures (in effect, their metabolic rate) is represented by the mouse-to-elephant curve [6], see Figure 4, with its representative equation

$$\text{Power available} \propto M^{0.734} \tag{1}$$

where M is the creature's body mass.

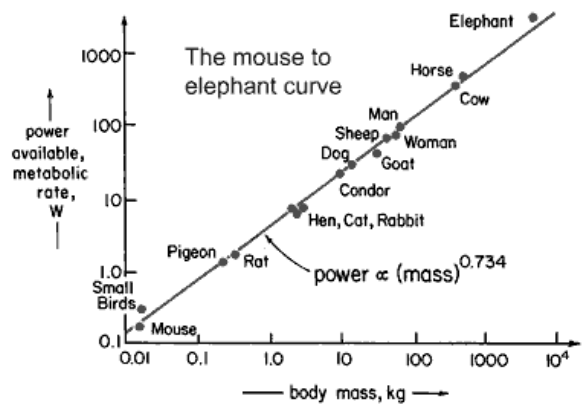

Figure 4. The "mouse-to-elephant" curve shows that the power of a warm blooded animal is proportional to its mass to the 0.734 power, as given by eq. 1.

Now the minimum power needed for the level flight of any creature was given by Renard [7] over a century ago as

$$\text{Power needed} \propto \frac{M^{3/2}}{\rho^{1/2} A^{1/2}} \tag{2}$$

where A is the wing area of the creature and ρ is the air density. It was pointed out by von Karman [8] that this expression is essentially what is used today by aerodynamicists and aircraft designers to represent the power needed to keep an aircraft aloft, from Piper Cub to the largest of passenger planes.

If L represents the size of the flying creature, then for creatures of different size but of similar geometry

$$\left\{ \begin{array}{l} \text{Mass, } M \propto L^3 \\ \text{Wing area, } A \propto L^2 \end{array} \right\} \tag{3}$$

Replacing eq. 3 in eq. 2, we find that the power needed for a creature to fly is given by

$$\text{Power needed to fly} \propto \frac{M^{7/6}}{\rho^{1/2}} \tag{4}$$

This is shown in Figure 5.

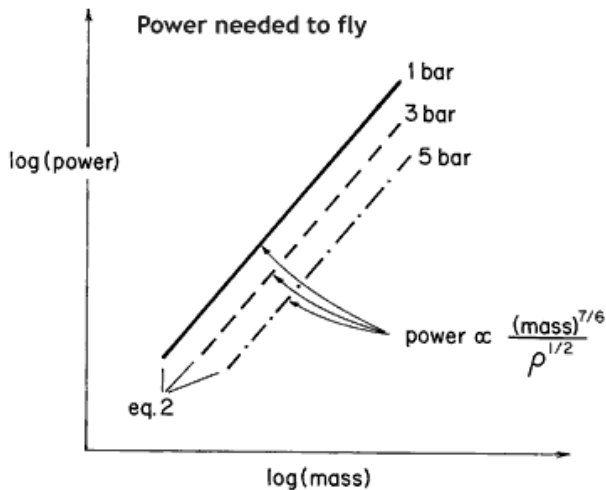

Figure 5. Aeronautics plus thermodynamics tells that the power needed to stay aloft depends on the creatures mass and the atmospheric density, as given by eq. 2.

Next compare the power needed to fly with the power available, see Figure 6.

This graph shows that there is always a maximum size above which no creature can fly. This limit today is the 4 m wingspan 14.5 kg bird. But how do we explain the existence of the 15 m wingspan, 86–100 kg quetzalcoatlus? Since the power needed is lower at higher atmospheric pressure, see eq. 2, let us propose that the atmosphere in the Cretaceous period was different from today's in that it was denser.

Comparing masses (86–100 kg vs. 14.5 kg) and assuming geometrical similarity, eq. 1 and eq. 4 combined leads us to conclude that the atmospheric pressure at the time of the quetzalcoatlus had to be about 3.2–4.8 bar. This is significantly greater than today's 1 bar. Graphically, we illustrate this conclusion in Figure 6.

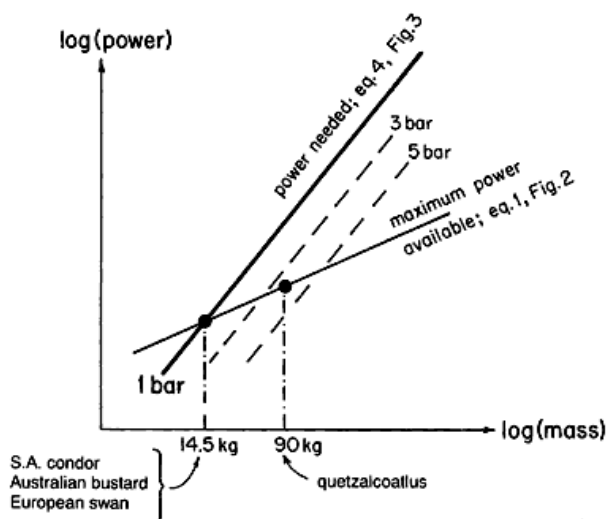

Figure 6. The maximum mass of today's flying birds is 14.5 kg. Heavier birds can fly in denser air.

THE AERONAUTICAL PROBLEM OF THE QUETZALCOATLUS

From a different point of view, from flight energetics, Figures 7 and 8 show the great flight diagram of Tennekes [13] (quetzalcoatlus point added by me). These diagrams clearly show that the points for the pteranodon and the quetzalcoatlus are far from the correlation for all of today's birds, today's insects and today's aeroplanes. To bring these points to the correlation line would require having a significantly higher gas density.

We know of no other scenario which can account for and explain why the metabolic rate of these giant flyers differs from all other warm blooded fliers, and why the flight energetics of pterosaurs is not consistent with all other flyers – from the smallest of insects, to birds and aircraft, all the way to the Boeing 747 (see Figure 7).

Again, the atmospheric pressure was higher then, than it is now.

The Problem of Pumping Blood to the Head of a Giant Dinosaur

There has been much discussion about how giant dinosaurs were able to pump blood to their brains. Let

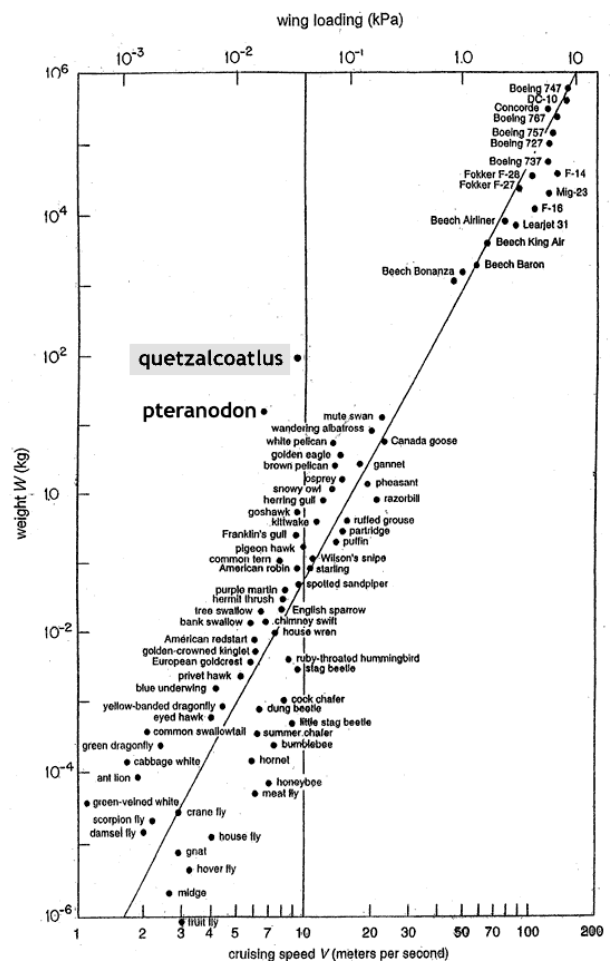

Figure 7. Prehistoric flyers do not correlate with today's birds, insects and aircraft.

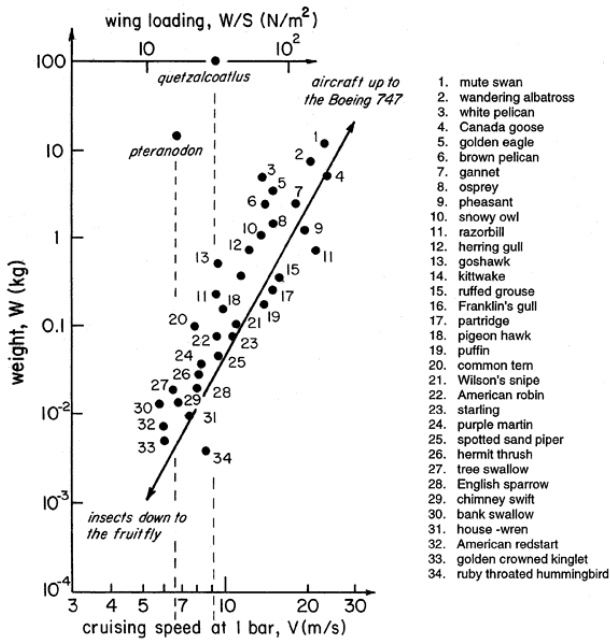

Figure 8. The bird section of Figure 7

us start by comparing a giant apatosaur with a giraffe, an elephant, and man as shown in Figure 9

	Apatosaur	Giraffe	Elephant	Man
Weight	35 tons	1.5 tons	5 tons	75 kg
Neck length	12.5 m	2.5 m	?	a few cm
Heart size	?	12 kg	?	1.5 kg
Pumping rate of blood	?	10L/s	?	0.1 L/s

These numbers suggest that the dinosaur heart should not weigh more than one ton. However, Pedley [14], taking into account the blood flow rate and the fact that the blood has to be pumped 10 or more meters upward, suggests that the heart should weigh about 5 tons. Whether one ton or 5 tons, it would be a giant heart pumping blood up to a high pressure, somewhat like that of an automobile tire.

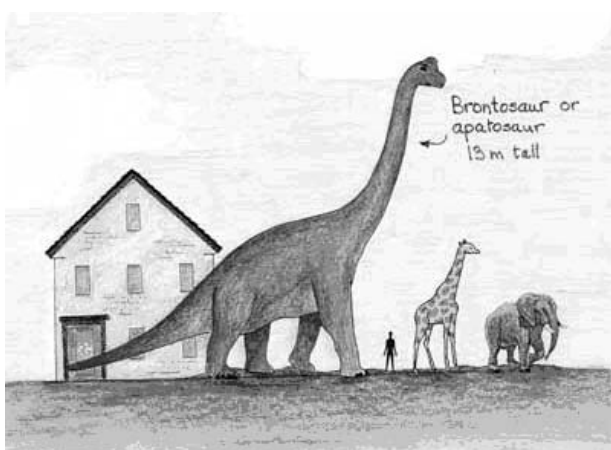

Figure 9. Relative size of animals

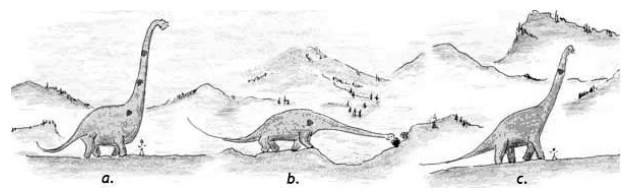

Figure 10. Proposed Explanations a) Dinosaurs with multiple hearts [15]. b) Horizontal necked dinosaurs who cannot raise their heads [17]. c) Dinosaurs with their hearts near their heads. This requires that the lungs be near the heart, but I do not know how to show this in the figure [18].

To overcome the problem of pumping blood to such heights paleontologists have all sorts of suggestions. First of all, Bakker [15] suggested that these giant creatures had to have more than one heart to be able to pump blood up the neck, see Figure 10a. However, this represents a most unlikely physiology.

A second group, Seymour and Lillywhite [16], said that dinosaurs held their necks horizontal or sloping downward slightly. A complex computer model by Stevens and Parish [17] seems to indicate that the apatosaur, with its unusual bone structure and its 12.5 m long neck, would be unable to lift its head more than 3–4 m, thus lending weight to this idea. Figure 10b shows the horizontal-necked dinosaur.

Other creative life scientists, Seymour et al [18] calling upon their imaginations, came up with still another idea; that dinosaur hearts were located, not in their chests, but up in their necks. This is shown in Figure 10c.

THE SIPHON EXPLANATION

Still another group of scientists proposed using siphons. Let us look at these devices. Figure 11 shows three situations, first where the siphon sucks fluid up from the heart and then returns it, secondly sideways and back, and finally downward and back up. The only power needed in these three arrangements is that

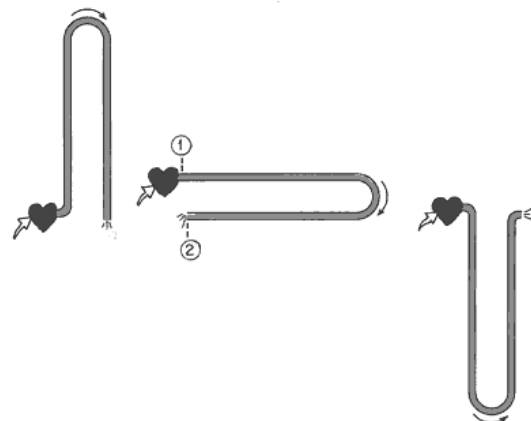

Figure 11. From the first law of thermodynamics the three flow systems in this figure all require the same pumping power

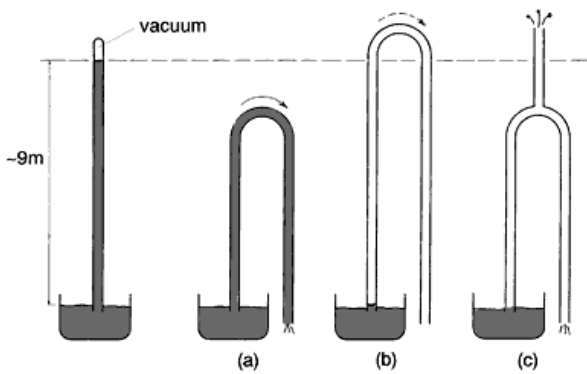

Figure 12. (a) Water siphons less than about 9 m high will work [20]. (b) Above about 9 m will not work. (c) Partial siphons have been proposed [16] but are just nonsense.

required to overcome the frictional resistance of the flowing fluid.

How high can a siphon work? Figure 12 shows that water can be sucked up about 10 m, minus about 1 m to account for frictional loss caused by fluid flow and by the vapor pressure of the water. So if a siphon tries to raise water more than about 8 m it won't work. Similarly, for blood with its different physical properties, a siphon can not raise blood more than about 7 m.

TALL SIPHONS

However, Seymour et al [18] overcame the tall-siphon difficulty by having the heart move up the

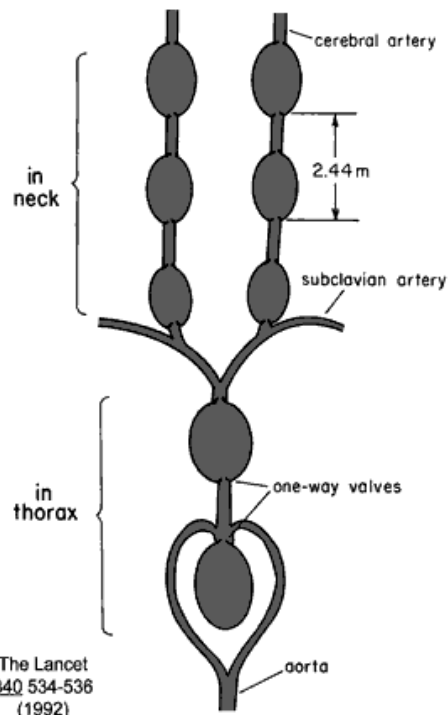

Figure 13. This design is clever but will not work. This figure is from Choy and Altman [19]

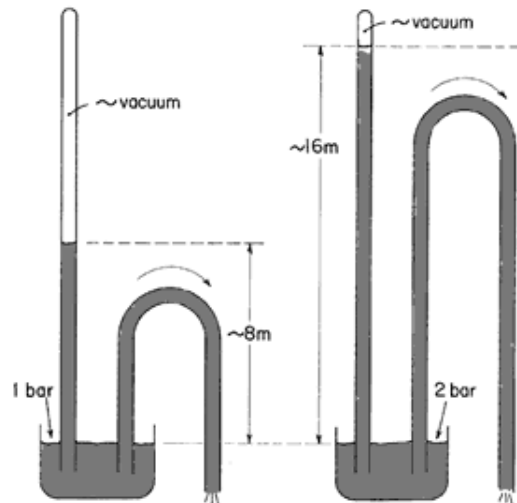

Figure 14. With a higher atmospheric pressure taller siphons will work

neck, see Fig 10c. Seymour and Lillywhite [16] later came up with the idea of using partial spiohnn, see fig. 12c. This is just nonsense.

Choy and Altman [19] have an even more creativeplan – use hearts and valves at 2 m intervals up the neck. Thus they propose that the Barosaurus has 8 hearts, two in the thorax, and three pairs in the neck, as shown by them and duplicated here in Figure 13. But fluid mechanics tells that this is pure fantasy.

Finally, by assuming a higher atmospheric pressure we have a physically reasonable explanation for how to operate a siphon taller than 7 m. Figure 14 shows that when the atmospheric pressure is roughly over 2 bar these long necked creatures could exist. Thus we tentatively conclude that the atmospheric pressure at the time of dinosaurs had to be higher than one bar or at least 2 bar.

At these higher atmospheric pressures taller siphons would work – at 1 bar 7 m high; at 2 bar 14 m high, and so on.

CONCLUSION

If you allow yourself to entertain the idea that a higher atmospheric pressure, say between 3 and 5 bar, could have existed in the time of the dinosaurs, it would resolve two of the anomalies that face us today, which are:

- how a dinosaur's heart could pump blood 7 or more meters upwards, without introducing the ideas of multiple hearts (as many as 8), giant hearts, and hearts located right under their chins, and
- how a giant flying quetzalcoatlus had the energy to stay airborne, something that biology and aerodynamics says is not possible in today's atmosphere.

All of this leads us to the next fascinating question – what was the atmospheric pressure before that time? Was it higher still? But this is another matter.

REFERENCES

- [1] R.T. Bakker, *Sci. Amer.*, **223** (1975) 58–78.
- [2] S. Wiesbaden, *Science News*, **130** (1996) 103 .
- [3] Wellnhofer, *The Illustrated Encyclopedia of Dinosaurs* , pg 142, Crescent Books, Random House, New York, 1991 .
- [4] D.A. Lawson, "Pterosaur from the Latest Cretaceous of West Texas: Discovery of the Largest Flying Creature," *Science*, **187** (1975) 947–948.
- [5] J.M. Smith, *Mathematical Ideas in Biology*, Chap. 1, Cambridge Univ. Press, (1984).
- [6] K. Schmidt –Nielsen, *Scaling: Why is Animal Size so Important?*, Cambridge Univ. Press, 1984.
- [7] C. Renard, "Nouvelles Experiences sur la Resistance de l'Air," *l'Aeronaute*, **22** (1889) 73; from [8].
- [8] T. von Karman, *Aerodynamics, Selected Topics in Light of their Historical Development*, McGraw Hill, 1963.
- [9] C.D. Bramwell and G.R. Whitfield, "Biomechanism of Pteranodon," *Phil. Trans. R. Soc. Lond.*, **B-267** (1974) 503–581.
- [10] E.H. Hankin and D.H. Watson, "On the Flight of Pterodactyls," *Aeronautical J.*, **72** (1914) 1–12; from [3].
- [11] O. Abel, "Geschichte und Methode der Rekonstruktion vorzeitlicher Wilbeltiere," G Fischer, Jena, 1925; from [3].
- [12] A.S. Romer, *Vertebrate Paleontology* , third ed., p. 146, U. Chicago Press, 1966.
- [13] H. Tennekes, *The Simple Science of Flight—from Insects to Jumbo Jets* , M.I.T. Press, 1996.
- [14] J.T. Pedley (G.I. Taylor Professor of Fluid Mechanics, Cambridge University), "Giraffes' Necks and Fluid Mechanics," broadcast October 25, 2003, on The Science Show on National Radio, U. K.
- [15] R.T. Bakker, *Nature*, **274** (1976) 661–663.
- [16] R.S. Seymour and H.B. Lillywhite, "Heart, Neck Posture and Metabolic Intensity of Sauropod Dinosaurs," *Phil. Trans. R. Soc. Lond.*, **267-B** (2000)1883–1887.
- [17] K.A. Stevens and J.M. Parrish, "Neck, Posture and Feeding Habits of Two Jurassic Sauropod Dinosaurs," *Science*, **284** (1999) 798–800.
- [18] R.S. Seymour et al, "Invited Review," *Am. Physiol. J.*, **265** (1993) R715–R720.
- [19] D.S.J. Choy and P. Altman, *The Lancet*, **340** (1992) 534–536.
- [20] H.S. Badeer and J.W. Hicks, "Circulation to the Head of Barosaurus Revisited," *Comp. Biochem. Physiol.*, **A114** (1996) 197.

AFTERTHOUGHTS

The 20th century experienced a revolution in thought about our planet. In 1915, Alfred Wegener, a meteorologist proposed that the continental land masses drifted about the world, wrote a book presenting these ideas [1], and supplied evidence to back his proposal.

The scientific community reacted with: "A pipe dream . a fairy story." Geophysicists, almost to a man, completely opposed this theory [2].

Lawrence Bragg in England was intrigued with this theory. He had it translated from the German and presented it at the Manchester Literary and Philosophical Society. Bragg related that the geology members were "furious." Until then, he added, he had never known what it meant to "froth at the mouth." In

fact, he said later, "Words cannot describe their utter scorn at anything as ridiculous as this theory" [3].

Here was Wegener, making an assertion for which his name would live in mockery for about 50 years. He was a target of scorn, and his theory provoked jibes, jeers, sneers, derision, raillery, burlesque, mockery, irony, satire and sarcasm, but it did not disappear [4].

After Wegener died in 1930, continental drift theory was all but forgotten, except that geology professors occasionally held it up to their students as a classical example of scientific blundering.

It is admirable how the persistent efforts of a handful of Wegener's converts were able to overcome the arrogance of the majority. It was not until the 1970s that the American geology establishment finally accepted this concept, and today we talk of continental drift as if we always believed it.

This present article is having a somewhat similar history. It asks us to consider that in the past the atmospheric pressure was much higher than it is now. In reviewing preliminary versions of this paper [5, 6] two authorities on geology and paleontology heaped ridicule on this proposal. Their review concluded with:

- "Large pterosaurs are said not to be able to fly in today's atmosphere for aerodynamic reasons; however paleontologists do not have a real problem with pterosaur flight."

- "Our fields of paleontology–geology are now and then pervaded from the so-called exact 'sciences' by ideas which have no basis at all ."

- "Physics has delayed our science for long periods over the last 150 years at least, it is very counterproductive."

This paper in its various versions has had a battered history. Here are the journals that were sent this paper and either returned it unread or just discarded it. Only one journal had the courtesy to review it before rejecting it.

1. *Science*, 1992
2. *Nature*, 1992
3. *American Scientist*, 1992
4. *Science*, 1993
5. *Nature*, 1993
6. *Geology*, 1993
7. *ChemTech*, 1993
8. *American Scientist*, 1994
9. *American Scientist*, 1996
10. *The Sciences*, 1996
11. *Endeavor*, 1996
12. *Chemical Engineering Education*, 1996
13. *Chemical Engineering Science*, 1998
14. *Science*, 1998
15. PUBLISHED in *Chemical Innovation*, May 2000, Dec 2000
16. *Nature*, 2004
17. *American Scientist*, 2004
18. *The Lancet*, 2004
19. *Geology*, 2005

It seems that this paper is too radical for today's journals. In the middle of the 1800 the Royal Society came across a similar situation. They turned down a paper which developed the important ideal gas law but they kept the original in their archive where Lord Rayleigh discovered it 50 years later. He then felt that he had to comment on this sad situation, so he wrote:

"Highly speculative investigations, especially by an unknown author, are best brought before the world through some other channel than a scientific society which naturally hesitates to admit into its printed records matter of uncertain value." Lord Rayleigh, Proc. Royal Soc., A183 1 (1892).

So here I present this "ridiculous" idea about our ancient atmosphere on internet. I think I have tried journals long enough to be rewarded with reviews such as "this is a waste of paper."

We should realize that any idea about our distant past is always accompanied by uncertainty; however, these ideas suggest new questions which add to the

idea or help to destroy it. One should question and explore new ideas and not dismiss them offhand with written reviews that say "We paleontologists don't believe in aerodynamic theory," "physics has delayed our field for over 150 years," and "this is a waste of paper" as was done with this paper.

Afterthought References

- [1] A. Wegener, *The Origins of Continents and Oceans*, translated from the 4th ed. by J. Biram; Dover, New York, 1966.
- [2] G.R. Stevens, *New Zealand Adrift*, Wellington, N.Z., 1980.
- [3] W. Sullivan, *Continents in Motion*, McGraw-Hill, New York, 1974.
- [4] J. McPhee, *Annals of the Former World*, Farrer, Straus and Giroux, 1981.
- [5] O. Levenspiel, T.J. Fitzgerald, and D. Pettit, "Earth's Early Atmosphere," *Chemical Innovation*, May 2000.
- [6] O. Levenspiel, T.J. Fitzgerald and D. Pettit, "Earth's Atmosphere before Dinosaurs," *Chemical Innovation*, Dec 2000.

IZVOD

ATMOSFERSKI PRITISAK U VREME DINOSAURUSA

(Naučni rad)

Octave Levenspiel

Departman za hemijsko inženjerstvo, Univerzitet države Oregon, Korvalis, Oregon, SAD

Ukoliko smo u mogućnosti da u mislima posetimo Zemlju u vreme kada su na njoj bili prisutni dinosaurusi susreli bi se sa neverovatnim i do danas nerešenim fenomenima. Na primer: kako su mogle da lete ogromne životinje koje su živele u to vreme na Zemlji, kao na primer quetzalcoatlus (raspon krila od 12–15 m) kada je to u suprotnosti sa današnjom aerodinamičkom teorijom i biologijom. Ili kao drugi primer, kako je bilo moguće da se kod džinovskog dinosaurususa, kao što je bio apatosaur, ostvari dotok krvi u glavu kada je ona na 13 m visine u odnosu na srce, kada je to u suprotnosti sa energetikom ovih životinja, a i sami fizičari kažu da je takav transport krvi od srca do glave nemoguće ostvariti u današnjim uslovima. Da li je neophodno da se promene osnovni zakoni fizike i biologije ili je potrebno da se razmišlja na jedan drukčiji način o ovim fenomenima? Moje mišljenje je da zakoni i dalje treba da važe, ali da je neophodno da se razmišlja da je atmosferski pritisak na Zemlji u ta davna vremena bio drukčiji od ovog kojeg danas možemo da izmerimo. Ovo predavanje je upravo usmereno u tom pravcu kako bi se na naučno-zasnovanim principima bolje osvetlila rošlost.

Ključne reči: Atmosferski pritisak, Dinosaurusi, Quetzalcoatlus, Apatosaur, Krvotok.